

Table of Contents

14 Design Patent	2
A Subject Matter	7
1 Articles of Manufacture	7
2 Ornamentality	10
3 Functionality	12
B Procedures	13
1 Drafting	13
2 Term	14
C Ownership	14
1 Novelty	14
2 Obviousness	16
D Similarity	18
1 Claim Construction?	18
2 Similarity	18
3 Filtration	19
E Prohibited Conduct	25
F Secondary Liability	26
G Defenses	26
1 Exhaustion	26
2 Free Expression	26
Problems	28
Problem: <i>Eames Chair, Redux</i>	28
Problem: <i>Tesla</i>	28

Design Patent

Design patents¹ are an interesting hybrid of IP concepts we have seen elsewhere. They borrow their basic structure from utility patent law: a designer obtains exclusive rights to a design by filing an application that is examined under the same substantive and procedural rules as a utility patent application would be. But the subject matter that is actually protected, and the infringement test used to measure similarity, looks much more like copyright. There are even hints of trademark-law confusion concepts in the historical infringement tests for design patents, although recent cases insist that whether consumers are confused is (mostly) not the right question to ask.

Design patent law has, until recently, been one of the most academically neglected fields of intellectual property law. The immense importance of design patents in smartphone litigation, however, has thrust them on the public stage again. There is a functionality test for design patents, but it is far more forgiving than in copyright or trademark.

The basic provision on design patents is Section 171 of the Patent Act:

Whoever invents any new, original and ornamental design for an article of manufacture may obtain a patent therefor, subject to the conditions and requirements of this title.

Most of the mechanics of obtaining a design patent are the same as for a utility patent. The principal difference is that designs are claimed by illustration rather than in words.² (An example follows.) This change has knock-on effects throughout design-patent law, because it means that utility patent's focus on the words of claims is completely inapplicable to design patents.

1. There are no canonical design patent treatises. Chisum's patent-law treatise has a chapter on design patents, and Matthew A. Smith has a draft treatise available online.

2. "Judges and lawyers in general are highly uncomfortable with images, yet design patents force direct legal engagement with images." Rebecca Tushnet, *The Eye Alone Is the Judge: Images and Design Patents*, 19 J. INTELLECTUAL PROP. L. 409 (2012).

United States Patent [19]

Giugiaro

[11] **Patent Number: Des. 283,882**

[45] **Date of Patent: ** May 20, 1986**

[54] **AUTOMOBILE**

[75] **Inventor: Giorgetto Giugiaro, Turin, Italy**

[73] **Assignee: Delorean Motor Company**

[**] **Term: 14 Years**

[21] **Appl. No.: 273,091**

[22] **Filed: Jun. 12, 1981**

[52] **U.S. Cl. D12/91**

[58] **Field of Search D12/91, 92; 296/185**

[56] **References Cited
PUBLICATIONS**

Road & Track, 3/73, p. 50, Lamborghini P250 Uracco, top right side of page.

Primary Examiner—James M. Gandy
Attorney, Agent, or Firm—David A. Maxon

[57] **CLAIM**

The ornamental design for an automobile, as shown and described.

DESCRIPTION

FIG. 1 is a front perspective view of an automobile showing my new design;

FIG. 2 is a rear perspective view thereof;

FIG. 3 is a front elevational view thereof; and

FIG. 4 is a rear elevational view thereof.

The side opposite to that shown in FIGS. 1 and 2 of the drawing is substantially a mirror image thereof.

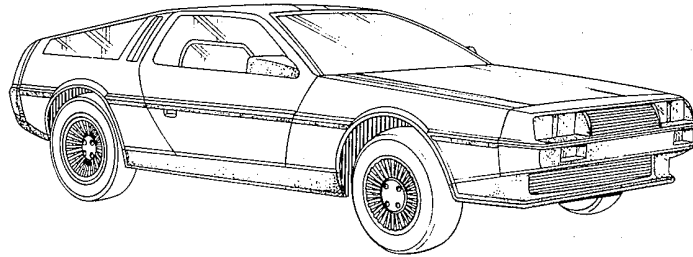

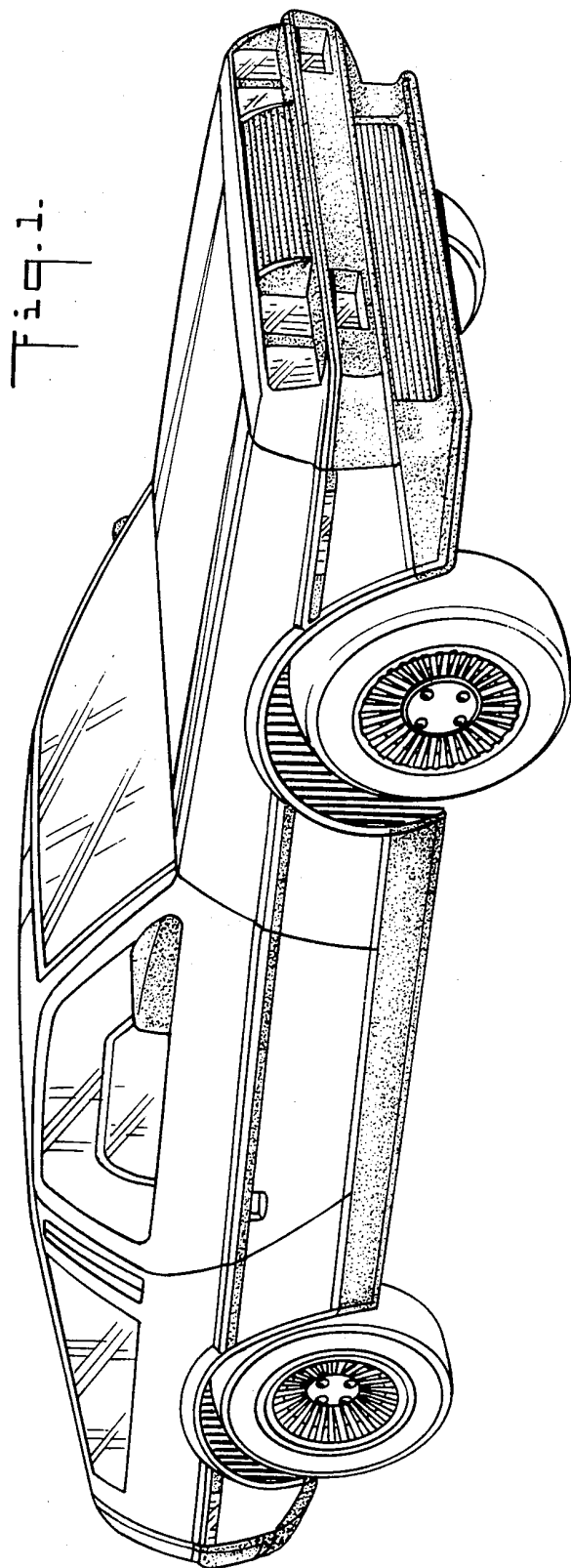

Fig. 2.

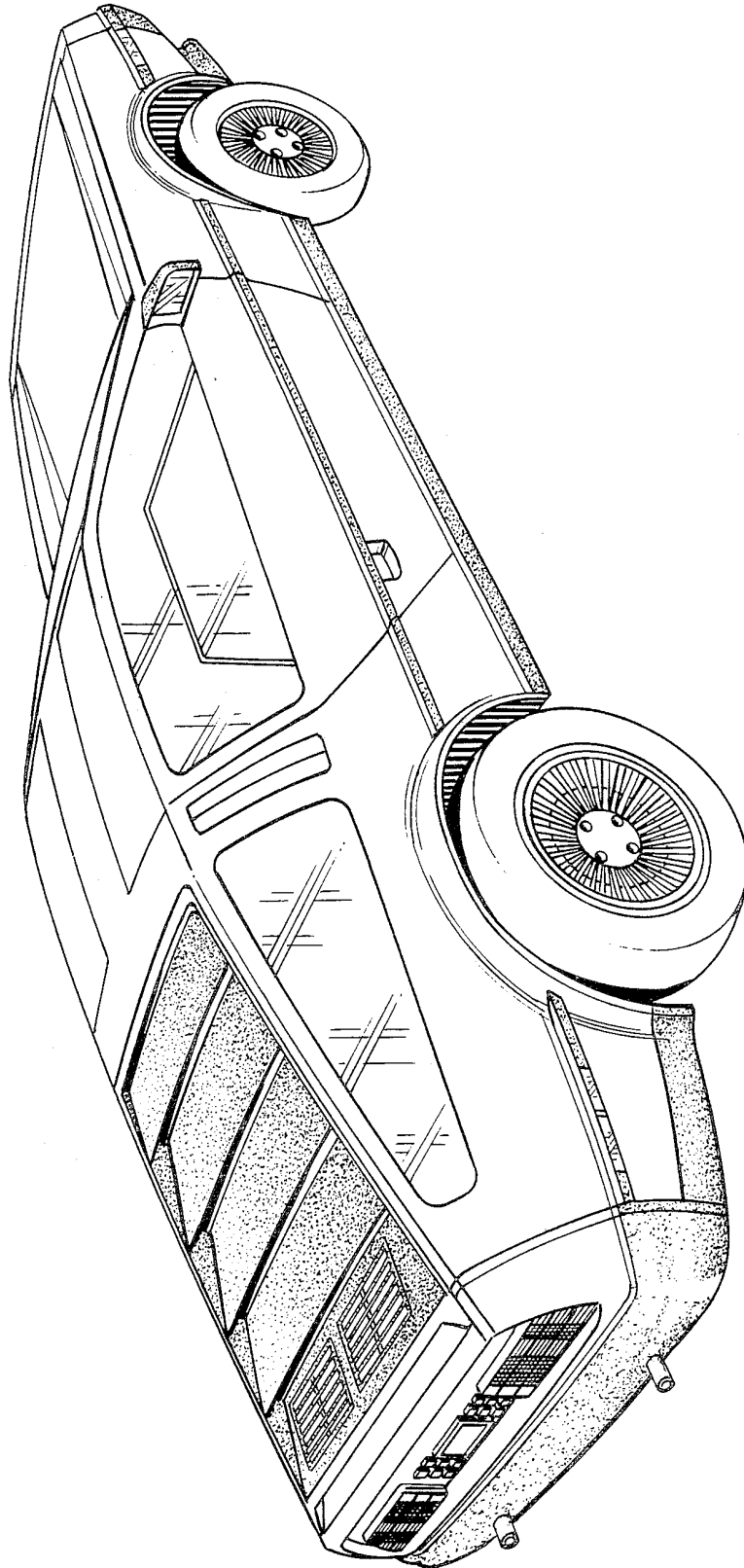

Fig. 3

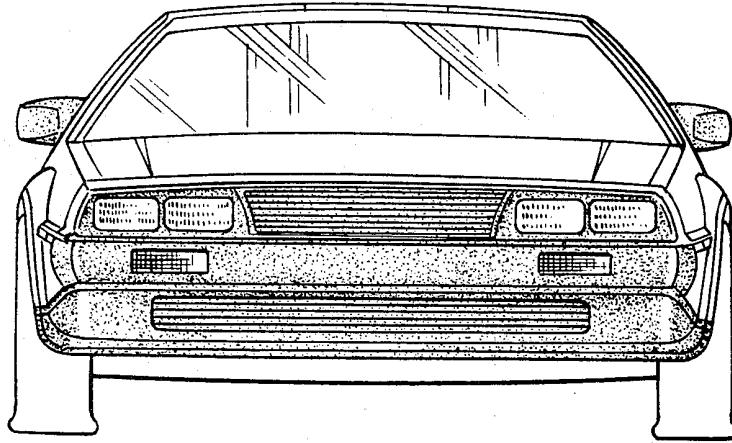
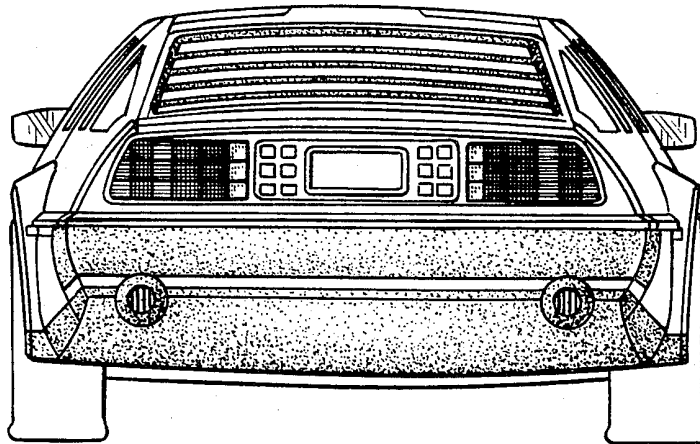

Fig. 4.



Consider, for example, infringement. To compare a utility-patent claim to an accused product, one proceeds element by element, checking whether the product contains a feature literally described by that claim element. But this method doesn't work for design patents. A drawing does not come broken down into a discrete list of elements; there is no claim language to construe. It is simply a design, complete in itself, unitary, and indivisible.

The classic statement of the test for design-patent infringement comes from the 1873 case *Gorham Co. v. White*, which involved silverware designs:

If, in the eye of an ordinary observer, giving such attention as a purchaser usually gives, two designs are substantially the same, if the resemblance is such as to deceive such an observer, inducing him to purchase one supposing it to be the other, the first one patented is infringed by the other.³

This is an infringement test that looks nothing like the one for utility patent. And yet design patents, like utility patents, are issued based on an examined application, and like utility patents they bind the world, even those who are unaware of them. This change, as we will see, has far-reaching implications all throughout design patent law.

A Subject Matter

Section 171 provides two subject matter threshold conditions: a design patent can apply only to a design for “an article of manufacture” and the design must be “ornamental.”

1 Articles of Manufacture

In *In re Hruby*, the CCPA held that an “ornamental design for a water fountain as shown and described” was directed to an article of manufacture.⁴ The claimed design was not for the fixed *base* from which the water sprayed, but rather for the pattern made by the *water* as it sprayed. The patent examiner had objected that water was a natural product, but so are wood and stone, and designs for chairs and paperweights made from them are certainly articles of manufacture. And the pattern was man-made in the same sense as a carved table is: “a raw material is put into planned patterns of motion for accomplishment of a decorative purpose.”⁵

The USPTO also raised a more fundamental objection to Hruby's design: that the patterns were “wholly a *fleeting* product of nozzle arrangements and control of operating pressure or pressures.”⁶ This should remind you of the argument from *Stern Electronics, Inc. v. Kaufman* that a videogame is unfixable because it constantly changes and disappears when the machine is turned off. And so should the response:

Although appellant did not disclose the particular means for producing the fountain effect, it is recognized that if certain

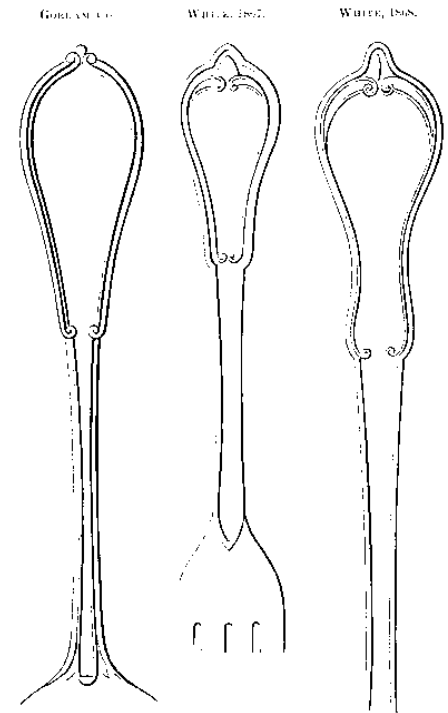

Plaintiff's and defendant's silverware designs

3. *Gorham Co. v. White*, 81 U.S. (14 Wall.) 511, 528 (1871).

4. *In re Hruby*, 373 F.2d 997 (CCPA 1967).

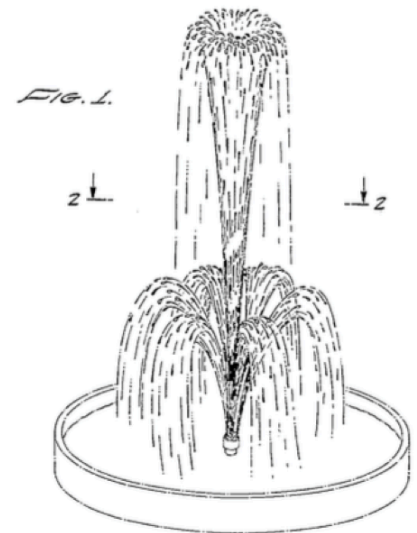

Figure 1 from Hruby's application

parameters such as orifice configuration, water pressure and freedom from disturbing atmospheric conditions are maintained, the ornamental shape of the fountain will remain substantially constant and will at such times present an overall appearance virtually the same from day to day.⁷

Indeed, every object is constantly (if very slightly) in motion. (An object that was completely still would have a temperature of absolute zero.) The drawings in the application did not disclose the exact position of every droplet of water, but the drawing of an object made of metal does not disclose the position of every molecule, either.

What matters with an ornamental design is only the ultimate over-all appearance of the article which embodies it. Technically, "exact" reproduction is an impossibility. It is always an approximation. We see no reason why design law — law being one of the greatest approximations of all — should be any more concerned with the "exact arrangement" of water droplets than it is with the exact arrangement of molecules, grains of sand, or even grosser building blocks so long as the general appearance is not affected.⁸

Thus, the design — and the design patent — were directed a thing that designers and customers treated as existing and as having a specific, reproducible design:

There is no doubt in our minds that prospective buyers of these fountains would select them for the decoration of buildings or grounds according to specific, reproducible designs, intending to use them as permanent decoration. The fountains are certainly made by man (manufactured) for sale to and use by such buyers. They certainly carry into effect the plain intent of the design patent statute, which is to give encouragement to the decorative arts.⁹

As for the objection that the fountain would not assume its distinctive design until turned on, the court responded that plenty of other objects don't assume their designs until used in certain ways:

A majority of this court recently held patentable a grille for a radio cabinet with a circularly brushed appearance which also had evenly-spaced small perforations. The peculiarity of this grille was that "with variations in viewing angle and ambient lighting" a varying moiré effect was produced and the majority felt that this effect made the ornamental appearance unobvious and patentable. The design was thus dependent, insofar as the feature which made it patentable was concerned, on something outside itself, it did not exist alone, because without the proper angles of ambient lighting and viewing there was no moiré effect.¹⁰ We do not see that the dependence of the existence of a design on some-

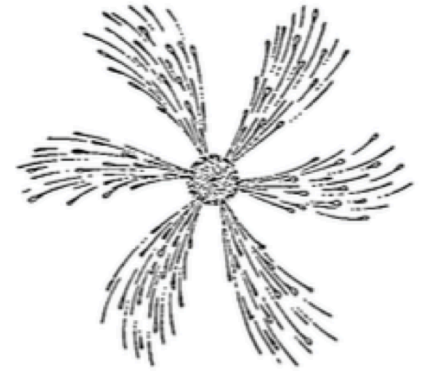

Figure 2 from Hruby's application

5. *Id.* at 999.

6. *Id.* (emphasis added).

7. *Id.* at 999.

8. *Id.* at 1000 n.3.

9. *Id.* at 1000.

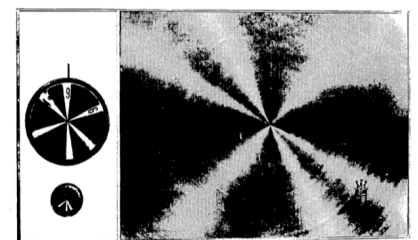

Boldt's radio cabinet. Unfortunately, the same moiré effect remarked on by the court also makes the image in Boldt's filing hard to copy or scan faithfully.

10. *In re Boldt*, 344 F.2d 990 (1965).

thing outside itself is a reason for holding it is not a design "for an article of manufacture." Many such designs depend upon outside factors for the production of the appearance which the beholder observes. The design of a lampshade may not be apparent unless the lamp is lighted. The design of a woman's hosiery is not apparent unless it is in place on her legs. The designs of inflated articles such as toy balloons, water toys, air mattresses, and now even buildings are not apparent in the absence of the compressed air which gives them form, as the water pressure here gives shape to the fountain. Even the design of wall paper is not always fully apparent in the commodity as it is sold and requires a wall and the services of a paperhanger to put it into condition for enjoyment by the beholder, which is the ultimate purpose of all ornamental design.¹¹

In dissent, Chief Judge Worley noted that the patentee already held a utility patent on the mechanism inside the fountain and that a design patent would "allow an individual to remove from the public domain and monopolize mere sprays of water."¹²

The instant sprays, so evanescent and fugitive in nature, presumably subject to the whims of wind and weather, incapable of existing in and of themselves, are merely the effect flowing from articles of manufacture, but certainly are no more articles of manufacture per se than are the vapor trails of jets, wakes of ships or steam from engines.¹³

Although the definition of "article of manufacture" is broad, a claimed design must be directed to a specific article, not merely to a design that could apply to any article. Such a rule is necessary to keep design patent from swallowing copyright law.

Consider *In re AlSabah*, where the applicant claimed an "ornamental design for a Teaching Aid for Teaching Arabic as shown and described."¹⁴ The design was a table of Arabic letters divided into numbered groups. The PTAB rejected her application as directed to non-statutory subject matter because the design was not embodied in or applied to an article of manufacture. It could be applied to a poster board, a coffee mug, a stepstool, or a pickup truck. It could be applied to anything. It was an *abstract design*, not a design for an article of manufacture. As the government explained in its brief on appeal,

A design patent may be obtained for a "new, original and ornamental design for an article of manufacture." An article of manufacture is a tangible man-made object. For example, a computer-generated icon shown on a computer screen is a patentable design on an article of manufacture. The icon itself is not patentable, but when claimed as an icon embodied on a computer screen, monitor, or other display panel, the combination of the icon and the display panel (or por-

11. *Hruby*, 373 F.2d at 1001.

12. *Id.* at 1002 (Worley, C.J. dissenting).

13. *Id.* (Worley, C.J. dissenting).

14. *In re AlSabah*, No. 2015-1264 (Fed. Cir. 2015).

Group	Lateefa Groups
1st	أ
2nd	ب ت ث د ه و ز ح ط
3rd	ج ح خ
4th	د ذ
5th	ر ز
6th	س ش
7th	ص ض ط ظ
8th	ع غ ف ق
9th	ك
10th	ل م ن ه و ي

AlSabah's design

tion thereof) is patentable as a design.

AlSabah claimed that “the design is printed on a piece of white paper, and a piece of white paper is an article of manufacture.” But this argument would destroy the article-of-manufacture requirement, because any applicant could put any two-dimensional design on paper and send it to the USPTO, thereby obtaining rights over the design as applied to any and all objects. AlSabah could have claimed her design for coffee mugs or for pickup trucks, but not an abstract design for all possible objects to which it might be applied.

The choice of article matters. A design patent on one kind of article cannot be asserted against a different kind of article. In *Curver Luxembourg v. Home Expressions*, a the owner of a design patent on a “pattern for a chair” sued the seller of a basket incorporating a similar pattern. *Held*, “the accused baskets could not infringe because the asserted design patent was limited to chairs only.”¹⁵

2 Ornamentality

A design is “ornamental” when it possesses some visual aesthetic appeal: it must be, in some small way, beautiful. This is not a high threshold. In *In re Koehring*, the applicant claimed a design for a “concrete mixer truck body and frame.”¹⁶ The Patent Office rejected the application on the basis that it was not “inventively ornamental,” citing an older case that had held a riveting machine to be

purely utilitarian, and without ornamentation of any kind. There is nothing about the assembled mechanical device which serves to beautify, embellish, or adorn it. The several parts of the mechanism, whether circular, curved, rounded, or spiral, are assembled into an entirety which is lacking in symmetry, wanting in grace, and destitute of any appeal to the senses or emotions. The design has no human interest, other than that aroused by the utilitarian nature of the machine.¹⁷

But the CCPA explained that Koehring’s design was ornamental, because:

In our view of the case, the beauty and ornamentation requisite in design patents is not confined to such as may be found in the “aesthetic or fine arts.” It is not reasonable to presume that Congress, in basing a patent right upon the ornamentation or beauty of a tool or mechanical device, intended that such beauty and ornamentation should be limited to such as is found in paintings, sculpture, and artistic objects, and which excites the aesthetic sense of artists alone.

By the enactment of the design patent law, Congress expressed a desire to promote more beauty, grace, and ornamentation in things used, observed, and enjoyed by our people. Appellant’s design of a truck body and frame for

15. *Curver Lux. v. Home Expressions*, 938 F.3d 1334, 1336 (Fed. Cir. 2019).

16. *In re Koehring*, 37 F.2d 421 (CCPA 1930).

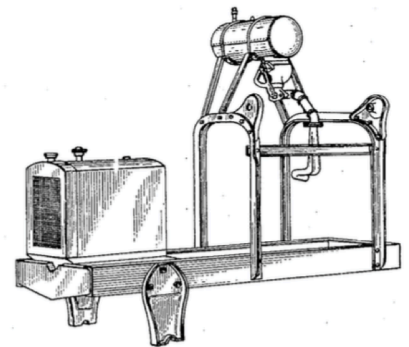

Koehring’s design

17. *In re Stimpson*, 24 F.2d 1012 (D.C. Ct. App. 1928).

a concrete mixer shows the frame to be so designed as to place the different elements of the whole machine, including the hood, gas tank, mixer, etc., into a more symmetrical and compact whole than was known in the prior art. Aside from this arrangement, which removes much of the unsightliness from the machine, the covering of the motor is made to resemble, in appearance, an automobile hood, and the angular bars and framework of the same are given a rounded or oval appearance. By the plan of assembly of the more or less rounded hood, round gas tank, and rounded frame corners into a compact and more symmetrical whole, an article, possessing more grace and pleasing appearance than existed in the prior art, has been produced. This effect in the design as a whole is ornamental and inventive.¹⁸

This discussion should remind you of *Bleistein v. Donaldson Lithographing Co.* It shares Justice Holmes's democratic and ecumenical attitude toward creativity; a design for a humble concrete mixer is just as worthy as a design for a fancy candlestick.¹⁹

The ornamentality requirement is not entirely toothless. The design must at least be *observable* in its "normal and intended use."²⁰ *In re Webb* provides a good example. The design there was for a prosthetic metallic implant to replace a patient's upper leg bone. In its normal use, a surgeon would implant the prosthesis in a patient's body, where it would remain indefinitely. The USPTO objected that this made the prosthesis invisible, so that its design could not be ornamental. But the Federal Circuit disagreed, explaining that the prosthesis would be visible to *doctors* in advertisements and at trade shows, when they selected what type of implants to use with their patients. Here is how it described the test for observability:

In short, we construe the "normal and intended use" of an article to be a period in the article's life, beginning after completion of manufacture or assembly and ending with the ultimate destruction, loss, or disappearance of the article. Although the period includes all commercial uses of the article prior to its ultimate destination, only the facts of specific cases will establish whether during that period the article's design can be observed in such a manner as to demonstrate its ornamentality.

It is possible . . . that although an article may be sold as a replacement item, its appearance might not be of any concern to the purchaser during the process of sale. Indeed, many replacement items, including vacuum cleaner brushes, are sold by replacement or order number, or they are noticed during sale only to assess functionality. In such circumstances, the PTO may properly conclude that an application provides no evidence that there is a period in the commercial life of a particular design when its ornamental-

18. *Koehring*, 37 F.2d at 422.

19. "Design applications which disclose subject matter which could be deemed offensive to any race, religion, sex, ethnic group, or nationality, such as those which include caricatures or depictions, should be rejected as nonstatutory subject matter." MPEP § 1504.01(e). Does this exclusion survive *Matal v. Tam*?

20. *In re Webb*, 916 F.2d 1553, 1557 (Fed. Cir. 1990).

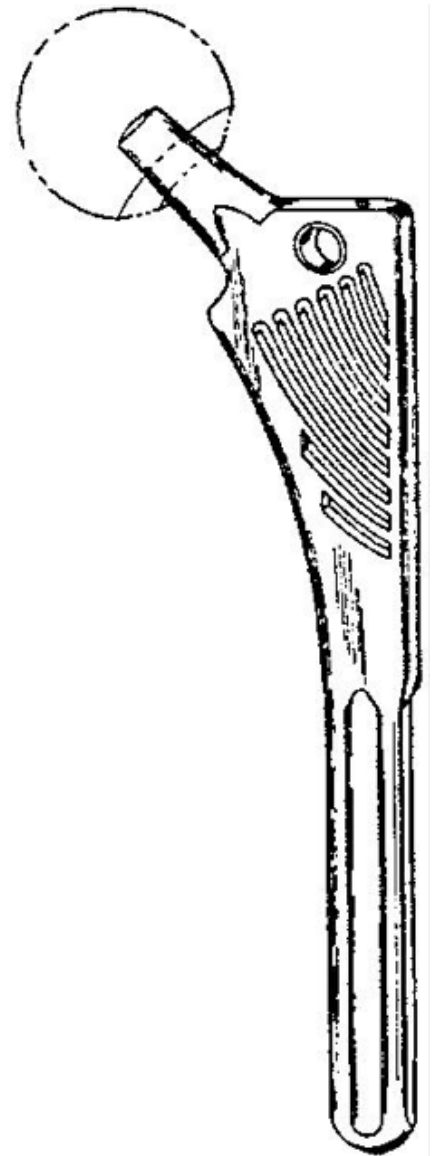

Webb's '470 design

ity may be a matter of concern. However, in other cases, the applicant may be able to prove to the PTO that the article's design is a "matter of concern" because of the nature of its visibility at some point between its manufacture or assembly and its ultimate use. Many commercial items, such as colorful and representational vitamin tablets, or caskets, have designs clearly intended to be noticed during the process of sale and equally clearly intended to be completely hidden from view in the final use.²¹

What about the concern that a doctor who selects an implant on the basis of *how it looks* rather than on the basis of *how it works* is in danger of committing malpractice? If you remember *Juicy Whip, Inc. v. Orange Bang, Inc.*, the drink-dispenser case, you can probably predict the Federal Circuit's response. It wrote, "[In the USPTO's] view, doctors should select implants solely for their functional characteristics, not their design. It is not the task of the [USPTO] to make such presumptions."²²

3 Functionality

A design patent is not a utility patent. A protectable design must have some ornamental aspects that are distinct from its functional aspects. So, like copyright and trademark, design patent must have a functionality screen that keeps purely functional subject matter from being protected. But, crucially, design patent's functionality test is far more permissive. Designs that would be obviously functional under copyright and trademark are *not* functional in design patent.

We apply a stringent standard for invalidating a design patent on grounds of functionality: the design of a useful article is deemed functional where the appearance of the claimed design is dictated by the use or purpose of the article. [For a design patent to be valid,] the design must not be governed solely by function, i.e., that this is not the only possible form of the article that could perform its function. When there are several ways to achieve the function of an article of manufacture, the design of the article is more likely to serve a primarily ornamental purpose. That is, if other designs could produce the same or similar functional capabilities, the design of the article in question is likely ornamental, not functional.²³

As an example, consider *Rosco, Inc. v. Mirror Lite Co.*, which involved a design patent (No. 346,357) on a "cross-view" mirror for school buses.²⁴ It is important for the driver to have an unobstructed view of the front and passenger side of the bus, and Rosco's oval-shaped mirror gave a wide field of view. Rosco marketed the superb wide field of view of its EAGLE EYE mirror and advertised its "aerodynamic" properties.²⁵ The Federal Circuit held that it was not functional:

The mere fact that the invention claimed in the design patent

21. *Id.* at 1558.

22. *Id.*

23. *Rosco, Inc. v. Mirror Lite Co.*, 304 F.3d 1373, 1378 (Fed. Cir. 2002).

24. *Id.*

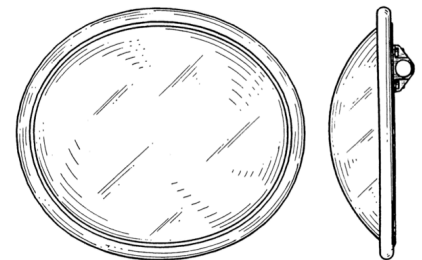

Rosco's '357 design

25. Convince yourself that this design would be unprotectable under copyright's useful-article test and trademark's functionality test.

exhibited a superior field of view over a single predecessor mirror (here, the Bus Boy) does not establish that the design was “dictated by” functional considerations The record indeed reflects that other mirrors that have non-oval shapes also offer that particular field of view. Similarly, nothing in the record connects the oval shape of the patented design with aerodynamics, and the record shows that other non-oval shaped mirrors have the same aerodynamic effect.

Mirror Lite has not shown by clear and convincing evidence that there are no designs, other than the one shown in Rosco’s ‘357 patent, that have the same functional capabilities as Rosco’s oval mirror. Under these circumstances it cannot be said that the claimed design of the ‘357 patent was dictated by functional considerations.²⁶

26. *Rosco*, 304 F.3d at 1378–79.

Is this rule a healthy way of providing coverage for a valuable kind of subject matter that would otherwise fall through the cracks between different IP regimes? Or does it undermine all of the hard work that goes into keeping them distinct?

B Procedures

Design patent prosecution is simpler than utility patent in some ways not here relevant. Instead, this section focuses on the distinctive drafting challenges posed by using drawings as a claim.

1 Drafting

A design patent typically has minimal specification. “[A]s a rule the illustration in the drawing views is its own best description.”²⁷ Instead, the heart of a design patent application is the drawings. The MPEP explains:

27. U.S. PAT. & TRADEMARK OFF., MANUAL OF PATENT EXAMINATION PROCEDURE § 1503 (2020).

A design patent application may only include a single claim. The single claim should normally be in formal terms to “The ornamental design for (the article which embodies the design or to which it is applied) as shown.” . . .

Every design patent application must include either a drawing or a photograph of the claimed design. As the drawing or photograph constitutes the entire visual disclosure of the claim, it is of utmost importance that the drawing or photograph be clear and complete, and that nothing regarding the design sought to be patented is left to conjecture.

The drawings or photographs should contain a sufficient number of views to disclose the complete appearance of the design claimed, which may include the front, rear, top, bottom and sides. Perspective views are suggested and may be submitted to clearly show the appearance of three dimensional designs.

Full lines in the drawing show the claimed design. Broken lines are used for numerous purposes. Under some circumstances, broken lines are used to illustrate the claimed design (i.e., stitching and fold lines). Broken lines are not permitted for the purpose of identifying portions of the claimed design which are immaterial or unimportant. There are “no portions of a design which are “immaterial” or “not important.” A design is a unitary thing and all of its portions are material in that they contribute to the appearance which constitutes the design.

The two most common uses of broken lines are to disclose the environment related to the claimed design and to define the bounds of the claim. Structure that is not part of the claimed design, but is considered necessary to show the environment in which the design is associated, may be represented in the drawing by broken lines. This includes any portion of an article in which the design is embodied or applied to that is not considered part of the claimed design. Unclaimed subject matter may be shown in broken lines for the purpose of illustrating the environment in which the article embodying the design is used. Unclaimed subject matter must be described as forming no part of the claimed design or of a specified embodiment thereof. A boundary line may be shown in broken lines if it is not intended to form part of the claimed design.²⁸

28. *Id.* §§ 1503.01, .02 (reordered).

2 Term

A design patent is valid for fifteen years from the “date of grant.”²⁹ Since design patent examination practice is generally expeditious, this term in practice will typically be shorter than utility patent’s twenty years from filing.

29. 35 U.S.C. § 173.

C Ownership

The rules on inventorship and initial ownership are largely the same for design patents as for utility patents. They pose more difficult questions when it comes to the tests for anticipation under § 102 and for nonobviousness under § 103. The difficulty flows from the fact that design patents use depictions rather than verbal claims, so that the claim-based tests used for utility patents simply map cleanly onto design patents.

1 Novelty

For the most part, the are the rules for priority and prior art are the same for design patents and utility patents. The timelines look the same, and so do the rules for what constitutes a printed publication, an offer for sale, and so on. The test for experimental use is a little different because what counts as necessary experimentation is different for ornamentation than for function. In *In re Mann*, for example, the applicant exhibited a

wrought-iron table embodying the design at a trade show, but argued that it was an experimental use. The court disagreed, writing, “Obtaining the reactions of people to a design – whether or not they like it – is not ‘experimentation’ in that sense. In the case of a design, if market testing shows that it has no appeal and the design is changed, the result is a new and different design; the original design remains just what it was.”³⁰

The test for anticipation is different, though, because the test for infringement is different. The general principle is the same: “that which infringes, if later, would anticipate, if earlier.”³¹ Thus, since the ordinary-observer test is used to establish infringement, it is also used for anticipation. A prior art reference anticipates a claimed design if an ordinary observer would regard the two as substantially the same.³²

In *International Seaway Trading Corp. v. Walgreens Corp.*, Seaway held design patents Nos. [D529,263](#), [D545,032](#), and [D545,033](#) on casual, lightweight footwear. The defendant argued held that these designs were invalid because they were anticipated by Design Patent No. [D517,789](#), on the notoriously iconic Crocs. Here is the court’s analysis:

The Crocs ’789 patent contains a long, U-shaped dimpling pattern on the insole. In contrast, the patents-in-suit have a dimpling pattern that includes multiple short rows of dimples. Because we cannot say that these differences are insignificant as a matter of law, a genuine issue of material fact exists as to whether the designs would be viewed as substantially similar in the eyes of the ordinary observer armed with the knowledge of the prior art. . . .

[Seaway] claims that four exterior features differ from the prior art to the degree necessary to preclude summary judgment: (1) the number and arrangement of the circular openings on the upper of the clog; (2) the number and position of the rectangular cut-outs in the lower portion of the upper of the clog; (3) the shape of the toe portion of the clog; and (4) the raised pattern of the outsole of the clog. These features are identical in all three of Seaway’s patents-in-suit. With regard to these alleged dissimilarities, the district court stated:

Slight variations on the number and position of the circular holes on the top of the shoe, the rectangular holes on the toe of the shoe as well as the design of different shaped rectangles on the sole of the shoe would not convince a reasonable jury, or an ordinary observer with knowledge of the prior art, that the limitations were not inherently disclosed in the ’789 patent. This conclusion does not change merely because plaintiff slightly changed the arrangement of the textured portions on the top and around the bottom portion of the sides of the shoe.

30. *In re Mann*, 861 F.2d 1581 (Fed. Cir. 1988).
31. *Peters v. Active Mfg. Co.*, 129 U.S. 530 (1889).
32. The test for anticipation of a utility patent is the mirror image of the *literal* infringement test. But the design patent infringement test bears more than a passing resemblance to the doctrine of equivalents in utility patents. What does this do to the symmetry argument? Should anticipation in design patents be confined to identical designs? Or is it all irrelevant, since obviousness under § 103 will take care of such cases?

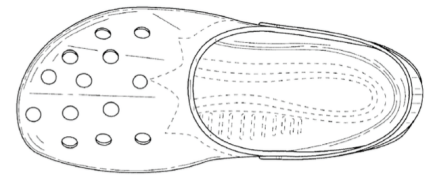

'789 insole

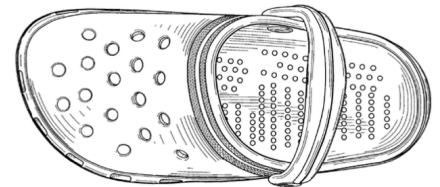

'263 insole

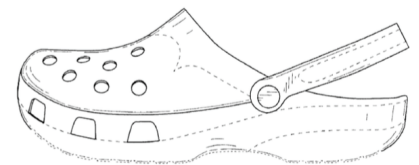

'789 side view

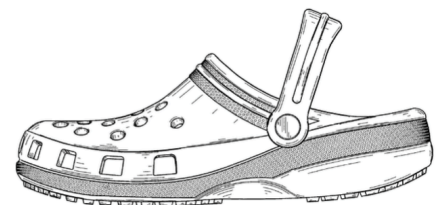

Fig. 2

'263 side view

We agree with the district court that these minor variations in the shoe are insufficient to preclude a finding of anticipation because they do not change the overall visual impression of the shoe. Although the ordinary observer test requires consideration of the design as a whole, this does not prevent the district court on summary judgment from determining that individual features of the design are insignificant from the point of view of the ordinary observer and should not be considered as part of the overall comparison. The mandated overall comparison is a comparison taking into account significant differences between the two designs, not minor or trivial differences that necessarily exist between any two designs that are not exact copies of one another. Just as minor differences between a patented design and an accused article's design cannot, and shall not, prevent a finding of infringement, so too minor differences cannot prevent a finding of anticipation.

2 Obviousness

The *Graham v. John Deere Co.* obviousness framework is nominally the same for design patents and for utility patents. But the application is very different. Under Federal Circuit precedent, if no single prior art reference is similar enough to the claimed design to meet the *Gorham* "substantially the same" test, the court must start by identifying a single prior art reference that is "basically the same" as the claimed design.³³ The choice of a reference can be made almost intuitively, but the court must explain in words the similarities between it and the claimed design. Then the court must consider whether a POSITA would have combined prior art references to arrive at the same overall visual appearance as the claimed design.³⁴ The primary and secondary references must be "related" enough that the appearance of a feature in one would suggest applying that feature to the other. For example, one barrel-shaped building could serve as a secondary reference for another barrel-shaped building.³⁵ The choice of initial prior-art reference and the final comparison are both judged from the perspective of an ordinary observer, but the choice to combine two references is from the perspective of a POSITA.³⁶

For an example of this analysis in action, consider *MRC Innovations, Inc. v. Hunter Mfg., LLP.* The defendant successfully argued that Design Patent No. **D634,488**, on an ornamental design for a football jersey for a dog, was invalid in light of the prior art.

The court started from an Eagles pet jersey as a primary reference. The patentee objected that there were significant differences between the Eagles jersey and the '488 design.

(1) the patented design has a V-neck collar where the Eagles jersey has a round neck; (2) the patented design contains an interlock fabric panel on the side portion of the design rather

33. Is there a meaningful difference between "substantially" and "basically?"
34. The concept of a POSITA comes from utility patent, where the POSITA combines functional features to create a useful invention. Does it make sense for combining ornamental features to create a not-solely-functional design?
35. *In re Borden*, 90 F.3d 1570 (Fed. Cir. 1996).

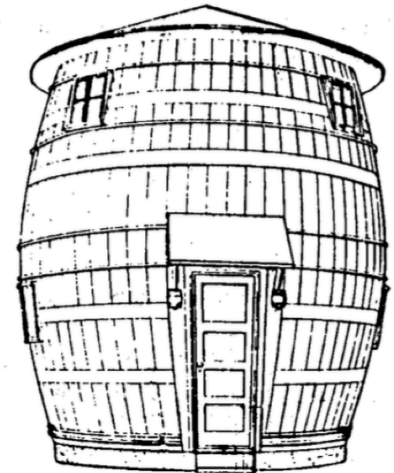

[A9036]

Prior art barrel-shaped building

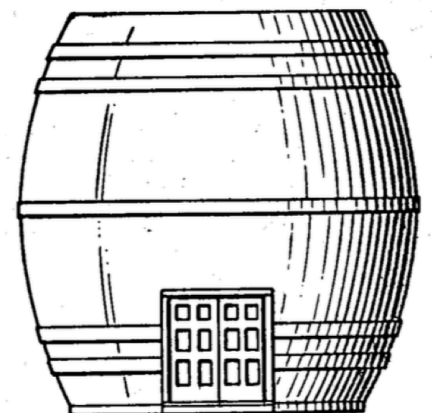

[A9037]

Barrel-shaped building design held obvious in light of prior art

36. Does this framework survive *KSR Intern. Co. v. Teleflex Inc.*?

than mesh; and (3) the patented design contains additional ornamental surge stitching on the rear portion of the jersey.

But the court noted that there were also key similarities:

[A]n opening at the collar portion for the head, two openings and sleeves stitched to the body of the jersey for limbs, and a body portion on which a football logo is applied. . . . [T]he Eagles jersey is made "primarily of a mesh and interlock fabric"; and . . . it contains at least some ornamental surge stitching – both features found in the '488 claimed design.

These designs created "basically the same overall visual impression," as required:

[B]oth designs contain the same overall shape, similar fabric, and ornamental surge stitching. That there are slight differences in the precise placement of the interlock fabric and the ornamental stitching does not defeat a claim of obviousness; if the designs were identical, no obviousness analysis would be required.

From here, the court considered two other pet sports jerseys – the V2 and the Sporty K9 – that both "suggested the use of a V-neck pattern and non-mesh fabric on the side panels." That left only one remaining different: the "surge stitching" down the back of the jersey. No prior art reference had surge stitching in that precise location. No matter, said the court:

Here, the Eagles jersey had already disclosed the use of ornamental surge stitching. The only additional step needed was to extend the stitching down the sides of the rear of the jersey. Moreover, the V2 jersey plainly suggested the addition of vertical lines down the rear of the jersey through the use of the seams between the two types of fabric. We agree with the district court that adding ornamental surge stitching on top of a preexisting seam was an insubstantial change that would have been obvious to a skilled designer.

In a footnote, the court qualified this holding a bit:

To be clear, we do not intend to suggest that merely because one prior art reference used ornamental surge stitching, any use of such stitching would have been a de minimis change. Rather, the addition of the surge stitching in this case was de minimis because it merely followed the visual lines created by the seams of the V2 jersey; in other words, it served only to highlight a design feature that had already existed in the V2 prior art jersey.

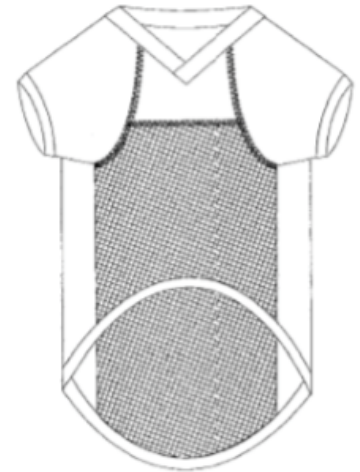

'488 design

D Similarity

This would be a good time to review the *Gorham* infringement test at the start of this chapter.

1 Claim Construction?

Claim construction is characteristic of utility-patent infringement analysis: the court reviews the language of a claim and states, explicitly, what it means as a matter of law. But because of the widespread legal belief that images are self-interpreting, claim construction is not typically part of design-patent infringement analysis. The Federal Circuit has described only a narrow role for the court in describing what a drawing “means”:

While it may be unwise to attempt a full description of the claimed design, a court may find it helpful to point out, either for a jury or in the case of a bench trial by way of describing the court’s own analysis, various features of the claimed design as they relate to the accused design and the prior art. Apart from attempting to provide a verbal description of the design, a trial court can usefully guide the finder of fact by addressing a number of other issues that bear on the scope of the claim. Those include such matters as describing the role of particular conventions in design patent drafting, such as the role of broken lines; assessing and describing the effect of any representations that may have been made in the course of the prosecution history; and distinguishing between those features of the claimed design that are ornamental and those that are purely functional.³⁷

2 Similarity

The *Gorham* ordinary-observer test should remind you of the ordinary-observer test used for copyright infringement. This is not a coincidence – the copyright test actually descends from the one in design patent! Any infringement test that involves comparing the aesthetic aspects of two things will have to look something like this. At least for the time being, the viewpoint of observers is ultimately the only standard we have available to compare aesthetic similarity.

This test should also remind you a bit of consumer confusion in trademark law. “[I]nducing him to purchase one supposing it to be the other” captures the core harm of unfair competition. The phrase “giving such attention as a purchaser usually gives” captures consumer sophistication and a comparison of the goods under marketplace conditions. Indeed, courts sometimes admit evidence of consumer confusion in the marketplace to prove similarity!³⁸ Relatedly, the rule that design patents only cover the identified articles of manufacture is a loose cousin to the similarity-of-the-goods factor in trademark. Chairs and baskets do not look like each other, so no one would confuse a basket for a chair.



“Eagles” design

37. *Egyptian Goddess, Inc. v. Swisa, Inc.*, 543 F.3d 665, 680 (Fed. Cir. 2008).

38. *OddzOn Prods., Inc. v. Just Toys, Inc.*, 122 F.3d 1396 (Fed. Cir. 1997).

At the same time, there is no requirement that the patentee shows that the defendant's product competes with its own, nor can a defendant avoid infringement by putting a disclaimer on its products.

Although it is dogma that patent infringement is judged by comparing the patent's claims to the accused product, design patent is a little less dogmatic about it than utility patent. Where the patentee's own product is the same as the claimed design, the court is permitted to compare the two products directly.³⁹ This direct comparison is possible because a design patent claims by exemplar: the drawings depict an ideal embodiment of the design, so an actual embodiment that is close enough to the ideal is almost as good as a starting point. It's not possible in utility patent because utility patents claim by characteristic, so every claim describes a range of possible embodiments that can differ substantially in their specifics.

3 Filtration

As you are all too well aware by now, one of the central problems in infringement analysis is filtering unprotectable aspects out from the plaintiff's thing before comparing it to the defendant's thing. In utility patent, this filtration takes place during prosecution: an issued claim is supposed to be narrow enough that it does not include *any* unpatentable matter. But design-patent prosecution *cannot play this role* because a design drawing does not come neatly separated into protectable and unprotectable aspects. Indeed, individual design elements may be familiar from the prior art, while their combination or variation is novel and nonobvious. The drawing does not distinguish between them.

Thus, design patent requires something closer to copyright-style filtration. The trier of fact must filter out any unprotectable aspects from the plaintiff's design before comparing it to the defendant's article of manufacture. For a time, the Federal Circuit held that the process of filtering out prior-art designs should be explicit. In *Litton Systems, Inc. v. Whirlpool Corp.*, it articulated a *point of novelty* test: as follows:

For a design patent to be infringed, no matter how similar two items look, the accused device must appropriate the novelty in the patented device which distinguishes it from the prior art. That is, even though the court compares two items through the eyes of the ordinary observer, it must nevertheless, to find infringement, attribute their similarity to the novelty which distinguishes the patented device from the prior art.⁴⁰

The point-of-novelty test worked reasonably well when there was one singular feature that made a design novel – a feature present in the design and not in any prior art. In the 1893 Supreme Court case *Smith v. Whitman Saddle Co.*, for example, the plaintiff's saddle design featured a sharp “drop at the rear of the pommel” which was not present in the prior art.⁴¹ Since the defendant's saddle lacked this drop, there was no infringement.

39. *L.A. Gear, Inc. v. Thom McAn Shoe Co.*, 988 F.2d 1117 (Fed. Cir. 1993).

40. *Litton Sys., Inc. v. Whirlpool Corp.*, 728 F.2d 1423, 1444 (Fed. Cir. 1984).

41. *Smith v. Whitman Saddle Co.*, 148 U.S. 674, 681 (1893).

The point of novelty test proved harder to explain and apply when several features of a design were novel, or when the novelty consisted of a new combination of existing features. Courts had to decide which feature or features was *the* point of novelty, and plaintiffs and defendants jostled over how to characterize it, taking infringement further away from the ordinary-observer inquiry supposedly at its core.

Thus, in *Egyptian Goddess, Inc. v. Swisa, Inc.*, the Federal Circuit abandoned the point-of-novelty test. Now the filtration is implicit instead of explicit. The fact-finder must “apply[] the ordinary observer test through the eyes of an observer familiar with the prior art.”⁴² It explained:

If the accused design has copied a particular feature of the claimed design that departs conspicuously from the prior art, the accused design is naturally more likely to be regarded as deceptively similar to the claimed design, and thus infringing. At the same time, unlike the point of novelty test, the ordinary observer test does not present the risk of assigning exaggerated importance to small differences between the claimed and accused designs relating to an insignificant feature simply because that feature can be characterized as a point of novelty.

This approach also has the advantage of avoiding the debate over the extent to which a combination of old design features can serve as a point of novelty under the point of novelty test. An ordinary observer, comparing the claimed and accused designs in light of the prior art, will attach importance to differences between the claimed design and the prior art depending on the overall effect of those differences on the design. If the claimed design consists of a combination of old features that creates an appearance deceptively similar to the accused design, even to an observer familiar with similar prior art designs, a finding of infringement would be justified. Otherwise, infringement would not be found.⁴³

For an example of what the *Egyptian Goddess* analysis looks like in practice, consider *Wing Shing Products (BVI) Co. v. Sunbeam Products, Inc.* The plaintiff, Wing Shing, claimed that Sunbeam’s AR series of MR. COFFEE coffeemakers infringed its design patent (No. [D348,585](#)). Considered in isolation, the two designs are visually similar:

42. *Egyptian Goddess*, 543 F.3d at 677.

43. *Id.* at 677–78.

'585 PatentAR 10/12 (Accused)

At the same time, the designs have some notable differences:

First, they have different bases: the '585 has a "bullnose" base – it is flat with a rectangular cross section up to the tip, where the top and bottom meet on a curve – while the AR 10/12 has a smooth base that slopes gradually from the heating plate. The designs also have dramatically different tops: the '585's is flat, whereas the AR's has a circular indent partially overhung by the lid to the water reservoir. As Sunbeam points out, these differences come at "focal points" in the designs: the top and base are the most visually commanding features of a coffeemaker, along perhaps with the brew basket.⁴⁴

In addition, Sunbeam presented prior art, including its previous Accel coffeemaker.

44. Wing Shing Prods. (BVI) Co. v. Sunbeam Prods., Inc., 665 F. Supp. 2d 357 (S.D.N.Y. 2009).

'585 patent



Accel (Prior Art)

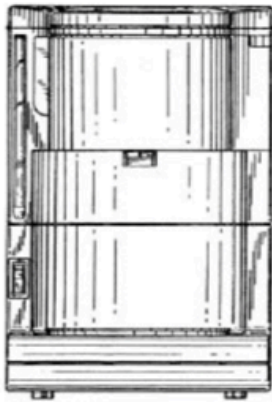

Here is the court's comparison of the Accel prior art to the '585 design patent:

The two designs are quite similar. Each has a large, smooth brew basket with a circular cross section that is partially encased by vertical shafts connecting the brew basket to the base of the machine. Each has a similarly shaped recess for the carafe. Both designs call to mind the familiar white or black coffeemaker that graces most American kitchens. As will be noted, differences exist, but on the whole the claimed design when compared to the prior art bespeaks "a field ... crowded with many references relating to the design of the same type of appliance."⁴⁵ Accordingly, the scope of protection afforded the '585 patent falls in a narrow range.

As for dissimilarities, the base is surely the most prominent observable difference between the designs. In contrast to the "bullnose" on the '585, the Accel has an angular base with a trapezoidal cross section. To the extent the devices have distinct overall appearances, their different bases supply them. There are additional minor differences – the top of

45. *Egyptian Goddess*, 543 F.3d 665.

the Accel is slightly crowned, while the '585's is flat; and the water reservoir on the '585 extends further around the circumference of the brew basket – but these small details do not make nearly the visual impression that the distinct bases do.⁴⁶

46. *Wing Shing Prods. (BVI)*, 665 F. Supp. 2d 357.

Putting it all together, the court compared the '585 design to the AR coffeemakers in light of the Accel prior art:

If the AR 10/12 (the accused design) had copied the '585's bullnose base – the one feature of the '585 that departs conspicuously from the prior art as depicted in the Accel – an inference of infringement might arise. Instead, the AR 10/12 has its own, unique base, as is all the more apparent when viewed alongside both the '585 and the Accel:



Because the AR 10/12 and the '585 differ at the very fea-

ture that primarily distinguishes the '585 from the Accel, no ordinary observer familiar with the Accel would be deceived into believing that the AR 10/12 and the '585 are the same. Indeed, since it is difficult to tell the '585 and the Accel apart without focusing on their bases, it would be unreasonable to conclude that any observer capable of distinguishing those two machines would confuse the AR 10/12 and the '585, which also have different bases. Additionally, the AR 10/12's unique lid configuration, which distances it from both the '585 and the prior art, further solidifies the conclusion that no genuine issue of material fact as to non-infringement exists here.

The Court remains mindful of the Federal Circuit's admonition to analyze the design as a whole and not engage in an element-by-element comparison of the devices in question. Nonetheless, when the prior art is used as a frame of reference, the tops and bases of the devices in question dominate the overall visual impressions they make. As *Egyptian Goddess* itself recognized, where a particular design element sharply distinguishes, against the context of the prior art, the claimed design from the accused design, it is not error to focus on that element in the infringement analysis.

Plaintiff argues that summary judgment cannot be granted here because, unlike in *Egyptian Goddess*, the AR 10/12 is closer to the patented design than the prior art. Plaintiff contends that the AR 10/12 is closer to the '585 patent than the Accel because the "body" of the AR 10/12 – the region from "the bottom of the lid to the top of the base" – is "substantially identical" to the body of the '585 design. The Court does not find this argument persuasive. First, in focusing on the "body" of the design, plaintiff has chosen a frame of reference that conveniently excludes the salient points of comparison – the top and the base. Under this framework, the Accel itself could be found to infringe, because to the layman's eye, its "body" is not readily distinguishable from the '585 patent. This is exactly the type of absurd result that consideration of the prior art is meant to avoid. Secondly, whether the accused device is "closer" to the patented design than to the prior art is not the controlling inquiry. *Egyptian Goddess* notes that strong similarities between the accused design and the prior art are an indication of non-infringement, but it does not require a mechanical determination – which in this case of "crowded art" would be impractical – that the accused device is "closer" to either the patent or the prior art. Instead, *Egyptian Goddess* requires an assessment of how the prior art will impact the ordinary observer's perception of the accused and claimed designs. Here, for example, though reasonable jurors might disagree

on whether the AR 10/12 is "closer" to the Accel or the '585 patent (it is different than both), no reasonable juror could dispute that an ordinary observer familiar with the Accel would not believe the AR 10/12 to be the "same as" the '585 patent.

quoting

Egyptian Goddess and *Wing Shing Products (BVI)* deal with prior-art filtration. Because a design patent protects only the ornamental features of a design, the functional features must also be filtered as part of the infringement analysis. Consider *OddzOn Products, Inc. v. Just Toys, Inc.* The plaintiff, OddzOn, held a design patent (No. **D346,001**) on a "foam football-shaped ball with a tail and fin structure."⁴⁷ It sold an embodiment of the design as the "Vortex" ball. It argued that Just Toys's "Ultra Pass" balls infringed on the '001 patent. The problem, which doomed OddzOn's suit, was that a tail-and-fin design helps a football fly further. Here is the court's analysis:

OddzOn argues that the shape of a football with an arrow-like tail is an ornamental feature because "it is not required for a tossing ball." While OddzOn correctly states that there are many ways of designing "tossing balls," it is undisputed that the ball in question is specifically designed to be thrown like a football, yet travel farther than a traditional foam football. It is the football shape combined with fins on a tail that give the design these functional qualities. The tail and fins on OddzOn's design add stability in the same manner as do the tail and fins found on darts or rockets. They are no less functional simply because 'tossing balls' can be designed without them.

Because the accused products are clearly similar to OddzOn's design in terms of their football shape and their tail and fins, it was incumbent on OddzOn to submit evidence establishing that the ornamental aspects of their football-with-tail-and-fin combination accounted for the similarity perceived by the survey participants. None of the evidence, when viewed in the light most favorable to OddzOn, would support a jury verdict that the accused devices are similar to the patented design with its football-shaped ball, slender tailshaft, and three fins which seemingly protrude out of the football and gently flare outwardly.⁴⁸

47. *OddzOn Prods., Inc. v. Just Toys, Inc.*, 122 F.3d 1396 (Fed. Cir. 1997).

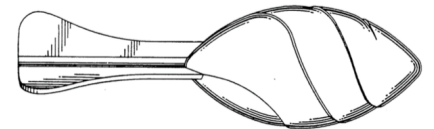

'001 design



Ultra Pass balls

48. *Id.*

E Prohibited Conduct

The usual theories of patent infringement under section 271 of the Patent Act (making, using, selling, and offering for sale) are also available for design patents, along with the usual remedies. In addition, there is a special provision for design-patent infringement in section 289 that provides an alternative remedy, which is often more attractive to the owner:

Whoever during the term of a patent for a design, without license of the owner, (1) applies the patented design, or any colorable imitation thereof, to any article of manufacture for the purpose of sale, or (2) sells or exposes for sale any article of manufacture to which such design or colorable imitation has been applied shall be liable to the owner to the extent of his total profit, but not less than \$250.⁴⁹

Nothing in this section shall prevent, lessen, or impeach any other remedy which an owner of an infringed patent has under the provisions of this title, but he shall not twice recover the profit made from the infringement.

As with utility patents, section 289 does not impose a requirement of copying from the plaintiff; design patents give a general right to exclude anyone from using the patented design. Design patents probably also borrow their rules on intent from utility patent law: one can infringe without knowing of the patent or intending to infringe it.

One thing that is distinctive about section 289 is that both prongs have explicit commerciality thresholds. They turn on "the purpose of sale" and on "sells or exposes for sale," respectively. Merely manufacturing a design-patented article for one's own use does not infringe under section 289 (although it does infringe under section 271). Similarly, the main new remedy is the infringer's "total profit": a wholly non-commercial use generates no profits.

F Secondary Liability

The usual rules of contributory and inducement liability under section 271 apply to design-patent infringement. But note that section 289 is silent on secondary liability. There is essentially no caselaw on point.

G Defenses

1 Exhaustion

The exhaustion doctrine applies to design patents. The sale of a design-patented article in the United States exhausts the patent owner's rights in that specific article, which can then be freely used and resold without the patent owner's permission. The repair/reconstruction distinction also applies to design patents. The article can be repaired to retain its design, but cannot be reconstructed to recreate the design once it has worn off or been destroyed.⁵⁰

2 Free Expression

Even more than utility patents, design patents can raise free-expression issues. Consider the "Peace Pretzel," a design for a pretzel in the shape of a peace sign, which was protected by design patent [D423,184](#). It was briefly asserted by its owner, Leslie Friend, against an online store, Laurel Hill Foods, selling peace-sign-shaped pretzels. In a copyright setting,

49. 35 U.S.C. § 289

50. See *Jazz Photo Corp. v. Int'l Trade Com'n*, 264 F.3d 1094 (2001).

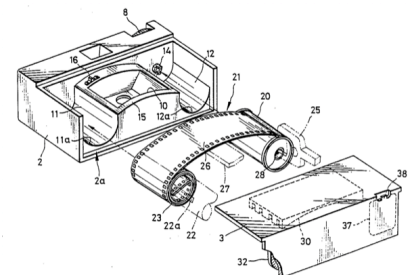
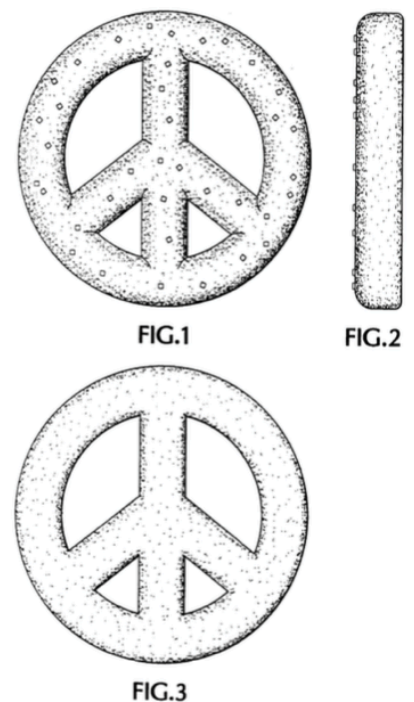

Figure 1, U.S. Des. Pat. No. [D345,750](#), "Single use camera."



'184 design

whether this use was allowable or not would have been a question of fair use. Ralph Clifford and Richard J. Peltz-Steele explain:

The missing piece in the *Friend* lawsuit, and the unresolved problem presented by design patents, is fair use. Insofar as *Friend* was a sympathetic plaintiff, Laurel Hill and Keystone were profiting off the ingenuity of another and may have been expected fairly to pay up. But change the defendant to a non-commercial user, and the case takes on a different cast. Imagine a city rally for Ukrainian-Russian peace at which a sponsoring ethnic bakery makes and gives away peace-sign-shaped pretzels. Or suppose that a German-American citizens group decides to counter community angst over immigration by uniting local persons of different backgrounds in Oktoberfest beer gardens to dialog over homemade peace-sign-shaped pretzels. Peace-sign-shaped cookies, adorned or not with sugar crystals, or other edibles, also might run afoul of the design patent, as the controlling diagrams say nothing about the edible ingredients.⁵¹

But design patent has no doctrine directed to free-expression concerns, no doctrine capable of making these distinctions. Clifford and Peltz-Steele again:

We can complicate the case further if we trade out the peace sign for a more controversial symbol. To choose a plaintiff that engenders less sympathy, suppose that the multinational oil and gas company BP obtained a design patent on a distinctive container for motor oil—let us borrow the double-sphere bottle in which POM Wonderful sells fruit juice. After the BP oil spill, a protestor and artist creates a sculpture depicting a blackened, oil-sodden pelican, surrounded by upturned BP oil bottles, also blackened, but recognizable by their shape. The artist might re-create (*make*) the bottles, or *use* discarded bottles. The artist might auction off (*sell*) the sculpture and donate the proceeds to an environmental advocacy group.

Critical training is hardly required to perceive the artist's message favoring environmental protection, or inversely, blaming BP for environmental degradation. But the work plainly runs afoul of the design patents, as the artist has made or used, and sold, the patented bottles. The ordinary observer properly perceives the BP bottles; indeed, the artist might be using BP bottles, which our auction winner buys because they are what they appear to be.⁵²

Does design patent need a fair use defense? Can you think of any other doctrines that might protect this hypothetical artist?

51. Ralph D. Clifford & Richard J. Peltz-Steele, *The Constitutionality of Design Patents*, 14 CHI.-KENT J. INTELL. PROP. 553 (2015).



Hypothetical anti-BP protest sculpture
52. *Id.*

Problems

Eames Chair, Redux

Look again at the Eames Lounge Chair. Could its design be effectively protected with a design patent?

Tesla

The following are pictures of a DMC DeLorean and a Tesla Model X. If DMC's '882 design patent were still in force, would the Model X infringe?



